

Implementation and analysis of MIMO system based on Alamouti coding

Fatema Saif Abdullah AL-Rawahi^a, Vidhya Lavanya R^a and Hashika Kaushalya Palitha Liyanage^a

Use of multiple antennas at the receiver and transmitter in a wireless network is a rapidly emerging technology that promises higher data rates at longer ranges without consuming extra bandwidth or transmit power. These systems can be with single-input multiple-output (SIMO), multiple-input single-output (MISO), or with multiple-input multiple-output (MIMO) architectures to improve the signal quality at the receiver using multiple data pipes over a link. MIMO communication system considers multiple antennas used at the transmitting end as well as the receiving end. In addition, the MIMO system has the ability to spread in the spatial domain which is combined in such a way that they either create effective multiple parallel spatial data pipes and diversity to improve the quality (for example decrease the bit error rate). The benefit from the multiple antennas arise from the new dimension space. Hence, the spatial dimension comes as a complement to time. MIMO technology also known as space-time 'wirelesses'. Space-time block coding (STBC) is a technique used in wireless communications to transmit multiple copies of a data stream across a number of antennas and to exploit the various received versions of the data to improve the reliability of data transfer. The Alamouti coding is a STBC coding technique that is widely use in wireless communication. Alamouti coding can be used in different models like using 2×1 MISO mode or a 2×2 MIMO mode and it can use OFDM system. The purpose of this project is to test a performance of wireless communication system under different type of noise, and the channel model. Also, implementation and analysis of MIMO system based on Alamouti STBC coding.

Keywords: MIMO; Alamouti coding; STBC; OFDM

Introduction

In olden times, communication was possible only with the help of an electrical conductor. Heinrich Hertz was the first to showcase the abilities of electromagnetic waves, and how they could be transmitted in space and be captured by the assigned receiver at another end. Thus wireless communication came into existence which made it possible to transfer information between two or more persons or point by use of wireless technology of electromagnetic waves without connections by electrical conductor.

It is a major revolution in communication technology as it has totally eliminated the use of wire and cables. It was first used for short distance communication like remote control device, cordless telephones and security system but later its widespread use came into mobile, GPS units, computer parts, and satellite communications too.

In wireless communication systems like mobile phones, the transceiver has limited power and also the device is too small in size, thus placing multiple antennas in it would lead to interference in the air because of the small separation between the antennas. To avoid this problem, multiple transmit antennas are placed on the base station and only one antenna on the mobile. This configuration is called multiple input single output (MISO). The two transmit and one receive antennas are known as Alamouti STBC and it is a special case of MISO systems. Alamouti scheme is a well-known scheme which provides full transmit diversity for such applications.

Encompasses within its framework, an entire series of other technologies like cellular phones, wireless broadband telephony and also the internet. Wireless communication has been a major boon to working professional who need to tackle urgent situation. But, unfortunately it has been a boon to hacker too grab wireless signals from the air, thus leading to security threats and exploitation of confidential information. Overall, wireless communication has changed the face of technology and led the betterment of lives of mankind.

The birth of multi-antenna is the direct result of the long-standing struggle to achieve high data rates without compromising the quality of reception. Multiple-input multiple-output (MIMO) system has been constructed by comprising multiple antenna and it yields to substantial increase in channel capacity.

Space-time coding as the name suggests involving coding which are space and time at the aim of approaching the best capacity of MIMO channel. MIMO wireless communication systems provides the capacity due to the multitude of modes available in channel. Present signaling technique for MIMO systems focuses on multiplexing to provide high data rates. [1]

In this work, the Alamouti coding MIMO systems is studied while sending random data (messages) and changing the transmission interference by echo cancelling. In addition, 16-QAM modulation system was selected to study the effect of modulation on the data transmitted. MATLAB Simulink simulation environment were used to study the overall system.

The objectives of the project are to test the performance of the transmitter and modulator under different types of noise and Channels. In addition, its higher data rates, which mean improved reliability and coverage this causes, increased number of users [2].

In this scenario, different types of noise effects to the signal will be studied when it arrives from transmitter to the receiver, like the thermal noise, intermodulation noise, cross talk noise and additive white Gaussian noise (AWGN), which is the most common type of noise in communication channels and it is easy to implement in simulation models. AWGN is statistically a random radio noise characterized by its wide

frequency range with regards to a signal in the communications channel. AWGN has set of assumptions which are:

The noise is additive: which means that the received signal equals the transmitted signal with some noise, where the noise is statistically independent of the signal.

The noise is white: this means that the power spectral density is flat, so the autocorrelation of the noise in time domain is zero for any non-zero time offset.

Literature Survey

This chapter will contain similar past technique to new network architecture for example mesh and also other one is sensor network. The project related to alamouti coding MIMO systems such as:

Network coded modulation (NetCodMod5G). Network coded modulation is an operation on data rather than channel codes. It has immense potential to increase the output of complicated communication networks. Its principle are used for the wireless domain as it processes incoming coded symbols. Its rectangular shape capacity gives it an advantages but still it has more drawback and limited usage. It processes incoming coded symbols but still requires information on other streams at destination. [3]

Space-time with signal processing technique for network communication. In simple word, it is the manipulation of a signals received from an antenna array for performance enhancing visage. The focus is mainly a blind signal separation and cancellation of co-channel interference, so a space time equalizer is used at the base station to combine this two signal processing aspect. Space time modems are also used to operate simultaneously on all antennas, as the signals arrive at the antenna with spatial signatures the modem exploits it to reduce co channel interference. [4]

Optimized Heterogeneous Multiuser MIMO Network. This is a multiple input and multiple output type of technology which is used for wireless communication broadcasting. Here, a set of wireless terminal are installed for communication, each having one or more antennas. There are various technologies like massive MIMO and ad hoc MIMO which provide spatial degree of freedom to individual users multiusers MIMO networks increase flexibility of wireless networking through increased multiuser interference. The nodes use either self-interference or user interference for improving data encoding and decoding. [5].

Improve detection technique for MIMO wireless communication. Multiple transmit and receive antennas are used for MIMO channels for increasing capacity. OFDM orthogonal frequency division multiplexing is considering most suitable for wide band transmission for enhancing the system capacity and to mitigate inter symbol interference. So the MIMO OFDM uses two spaces time codes for two transmit antennas. At the receiver, the codes are decoded based on successive cancellation of interference. Thus increase in number of receiver antennas improves OFDM system performance. This detection provides super-efficient wideband transmission. [6].

Physical layer security of wireless networks is a concept which is fundamentally different from other system as in this, the physical layer properties of the communication system are exploited for attaining secrecy. Interference, nature of fading channels with respect to time are the system exploited so as to considerably improve the communication security in wireless networks. This is needed when people become increasingly dependent upon wireless devices for personal communication thus this solves problem of confidentiality. Here, the signals of eavesdroppers are indirectly manipulated. [7].

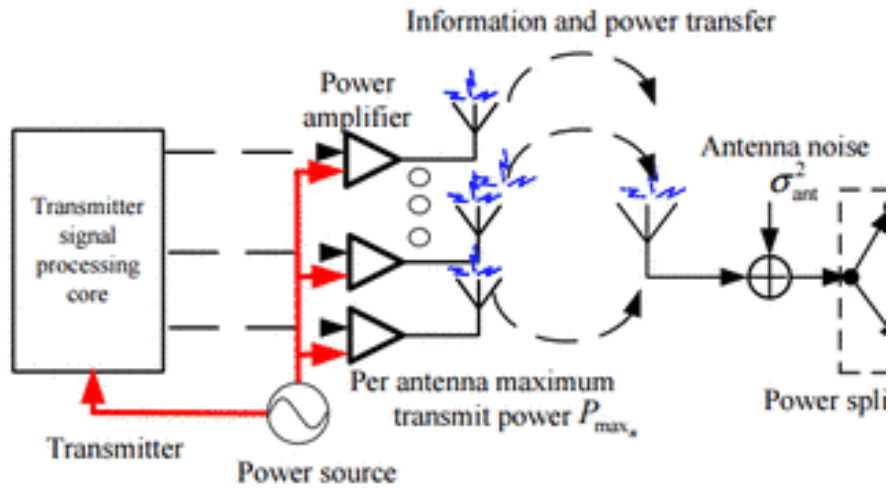

Figure 1. Physical layer of wireless network.

Figure 1 represent the physical layer of wireless network. Dense Cooperative Wireless Cloud Network –wireless communication is considered to be in dense mode where the wireless network coding message are sent through dense air interacting nodes in self-contained cloud. But the air interference between terminals and cloud has uniformity and simplicity. Thus, the problem of wireless communication in densely interfering and hoc networks can be solved by paradigm of virtual relay based self-contained clouds that have processing capability. This concept is capable of performance in random network domains and topologies.

In addition, in order to exhibits practical, it focused in high impact result DIWINE which is concentrate on two application such as:

- Smart metering networks.
- Critical industrial monitoring and control applications.

This both application have low latency and dense network. Also is sure to be integrated to future in European policy and society. [8].

Low complexity delay- tolerant space-time block coding. Signal processing and modulation technique for transmit diversity over fading channel has been deeply researched. Since a severely a attenuated signal cannot be recovered , so diversity technique are used to provide less attenuated replicas of transmitted signals to the receiver. Linear space time block codes are constructed by combining rotated constellations, and full transmit diversity is proven over fast fading channels. The codes transmit at rate of one symbol per second. The codes get constructed by sending component of rotated version of the symbol vector over diagonal of code matrix. Codes maintain their or orthogonal design and decoding is done by sphere decoder at moderate complexity. [9]

FP7 beyond Next Generation Mobile Broadband the object of this project is to increase overall mobile network infrastructure capacity density by the usage of new deployment strategy. This will have maximum usage in urban areas where demand for wireless broadband is very high. It anticipates an increase of 10 times current magnitude up to 1G bps/km2. A denser base station grid below rooftops will bring the backhaul network, then combination with high spectrum efficiency by use of novel antennas using heterogeneous radio elements will achieve maximum system capacity. [9].

Co-operative MIMO Output for Wireless Mesh Network. Wireless mesh network and cooperative communication together from a new architecture comprising of wireless mesh backbone formed by mesh routers and gateways. The clients must access the mesh router backbone, So as to get connected to gateways. Closely knit client get direct access but distant client need multi hop communication for getting connected. It can consist of rectangular grids for mesh client and every grid is collected

by mesh router and subsequently transferred to the gateway. “mesh cloud ” is the most suitable terminology for this network. There can be fixed or mobile nodes in this network. When MIMO is merged, the power consumption, network robustness and latency drastically improve. [10]

Time coding based on adjustable code project. This is adaptive DSTC scheme that proposes two hop cooperative MIMO network. In this, an adjustable code matrix obtained by a feedback channel is employed for transforming the space time coded matrix at the relay mode. Then effects of feedback errors are assessed, linear expression and algorithm are developed with reduce computational complexity to compute parameters of the code matrix. The simulation result show the performance gains. The use of DSTC at relay nodes, offers diversity and coding gains to mitigate the interference.

Improved detection technique for receiver oriented MIMO-OFDM systems. This system aims for the improvement of spectral efficiency of very high data rate communication systems. So MIMO detection methods are applied on PDF and BLAST technique. Without compromising on system complexity, simulation result show that the receivers outperform ZF, MMSE and V-BLAST. It makes use of a QR decomposition of the channel matrix for each sub carrier and successive interference cancellation (SIC) structure. Its performance is enhanced further by possibility of weighing of detected symbols based on estimate channel coefficients and soft decision Viterbi decoding. [11]

Building wireless sensor networks, Sensor networks have become more viable by wireless communications digital electronics and micro-electromechanical systems technology. First the sensor networks are previewed and then list of influencing factors is made. The sensor network protocols and algorithms have self-organizing capabilities. Sensor nodes have on-board processor, so the raw data does not go to sensor nodes, instead do self-processing for simple computations and finally transmit only required data. [12]

System Design and implementation

From the systems block diagram from figure 2, it is clear the input data (random message) are first subjected to 16-QAM modulation and the output of the modulator is divided into two parts. The first parts goes to the OFDM system, while the second part goes to Alamouti transmitter (Tx). The transmitted signals by Alamouti and OFDM through the wireless channels are all exposed to noise like AWGN noise. Finally, the signals are received at the receivers (Rx) and the error caused by noise is removed using 16-QAM modulation.

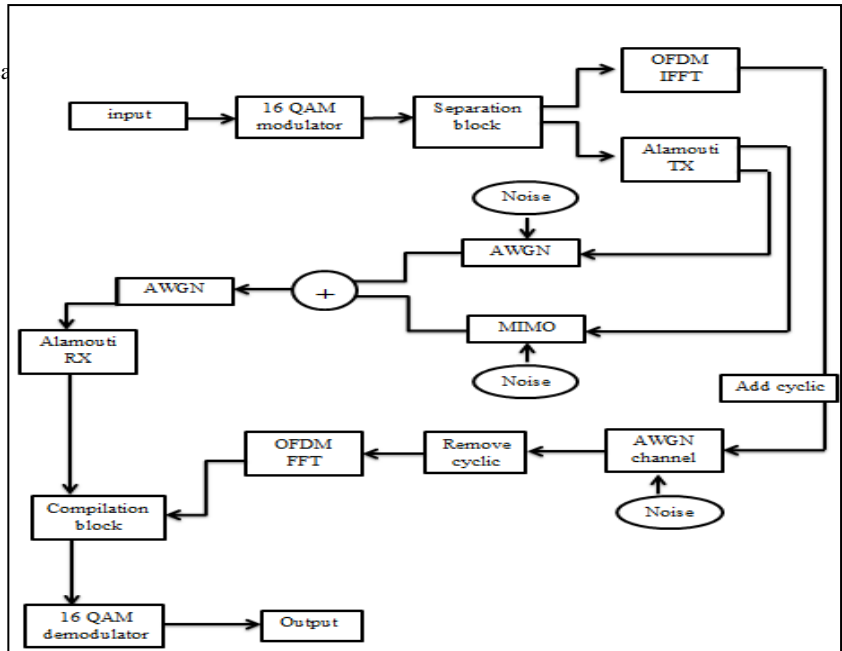

Figure. 2. Block diagram of MIMO system

The modern radio system uses multiple antennas on transmitter and receiver side, this is described as multiple input multiple output (MIMO) system. Fig 2 represent the block diagram of the MIMO system. Because the MIMO systems receiver receives, a weighted superposition of all transmitted streams is x , the MIMO systems received signal at a different time instant n . So it can be described as:

$$Y(n) = \sum_{l=0}^L H(l,n)X(n-l) + W(n)$$

Also can calculate the SNR between wanted and unwanted signal by:

$$SNR = \frac{P_{signal}}{P_{noise}}$$

$$SNR = \frac{P_t G_t G_r \sigma \lambda^2}{(4\pi)^3 R^4 KTB}$$

L is the number of taps of impulse response that is mean channel capacity.

The MIMO channel capacity compute as

$$C = \{\log_2(\det(I + \sigma^2 HH^2))\} \quad n_R \geq n_T$$

n_T, n_R = Number of transmitter and receiver antenna

σ^2 is the average to noise ratio (SNR)

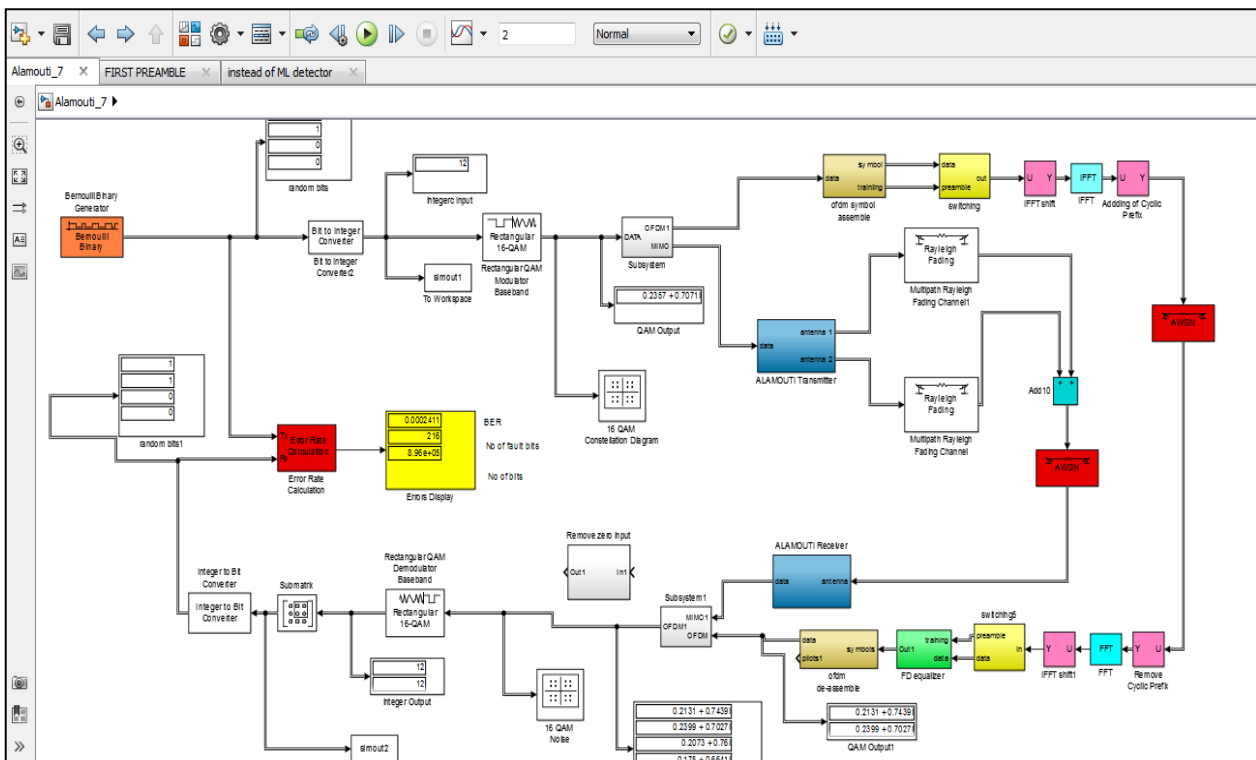

Figure 3. Overall Alamouti system with 16-QAM modulation and OFDM

Figure 3 shows the overall Alamouti system with 16-QAM modulation and OFDM. The final yellow block displays the error between the data transmitted and received which is the Bit-Error Rate (BER). It also counts the total number of bits transmitted. The number of bits transmitted increase as the simulation time increases. Here we tried to make the simulation time is 4s.

Results and discussion

To study the effect of different channel models, in Simulink the two channels representing the two Alamouti transmitters were changed to Jakes, Flat, Gaussian, Rounded, Bell, Restricted Jakes, and Bi-Gaussian.

Table 1. BER changes respect to different value of SNR

Delay		Channel model		BER	SNR	No of bit
1.5	3	Jakes	Jakes	0.1189	-0.25	64×10^3
2	4	Jakes	Jakes	0.1349	-1	125×10^3
3.5	5	Jakes	Jakes	0.1132	0	256×10^3
2	7	Jakes	Jakes	0.08182	1.5	320×10^3
4	2.5	Jakes	Jakes	0.05374	3	448×10^3
4	1.5	Jakes	Jakes	0.03078	4.5	512×10^3
6	4.5	Jakes	Jakes	0.0147	6	640×10^3
5	1	Jakes	Jakes	0.00552	7.5	640×10^3
6	5	Jakes	Jakes	0.001531	9	704×10^3
6	4	Jakes	Jakes	0.000442	10.5	768×10^3
7	5	Jakes	Jakes	0.000256	12	896×10^3
7	2	Jakes	Jakes	0.000241	15	896×10^3

Table I shows the different values of SNR and BER while changing the channel models for transmitter 1 (Rx1) and transmitter 2 (Rx2). It is clear that the relation between SNR and BER is inversely proportional, where increasing the SNR value will decrease the BER or the error.

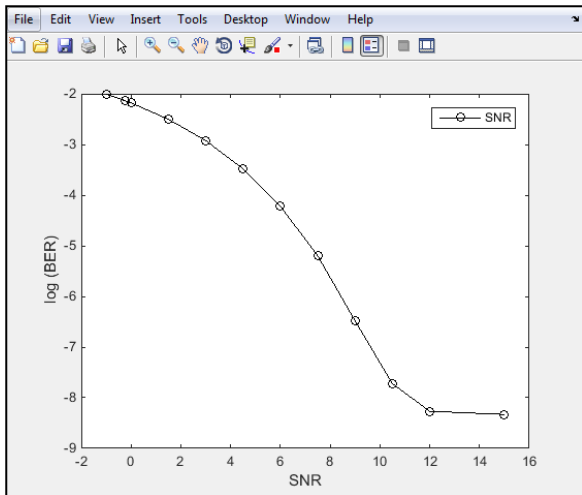

Figure 4. BER when value of SNR change

Figure 4 shows the result of BER against the SNR change, which is clearly shows that the BER decreases as the SNR value increases. So there are a negative relationship between them and this true since the noise is close to zero, the BER will be close to zero.

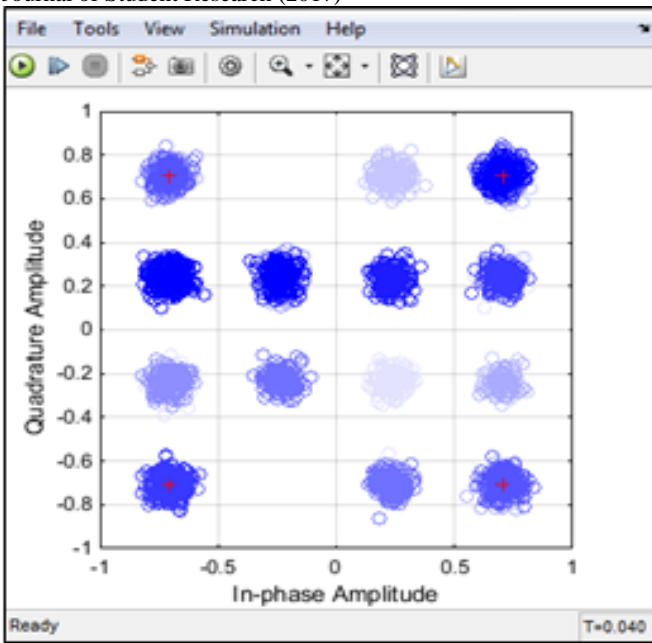

Figure 5. The modulated bits using 16-QAM when SNR is 15 dB

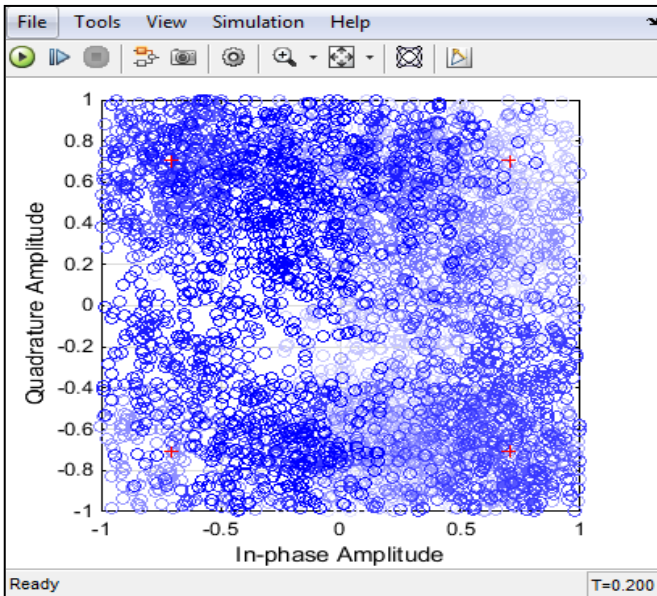

Figure 6. The modulated bits using 16-QAM when SNR is -0.25 dB

Figure 5 explains the modulated bits of the 16 bit QAM if the SNR is 15dB. Figure 6 represent the modulated bits using 16 QAM when SNR is 0.25dB.

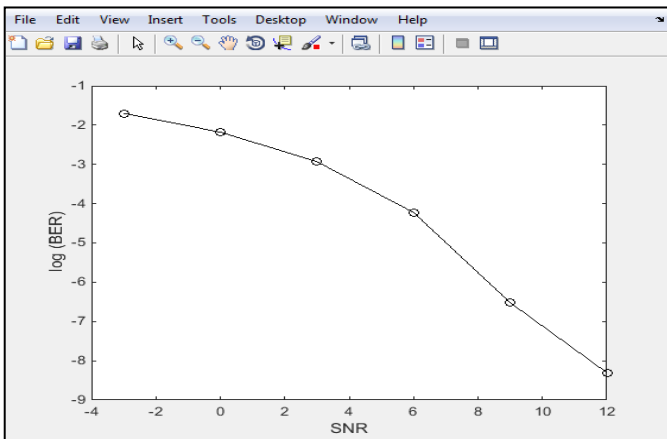

Figure 7. Result BER when SNR value change

Figure 7 shows the graph of BER when the value of SNR changes, and it decreases while the SNR increases. This means that they have a negative relationship between them. Figure 8 shows the graph of BER when fixed SNR to 1.5 and channel delay are Jakes, while varying the value of the delay.

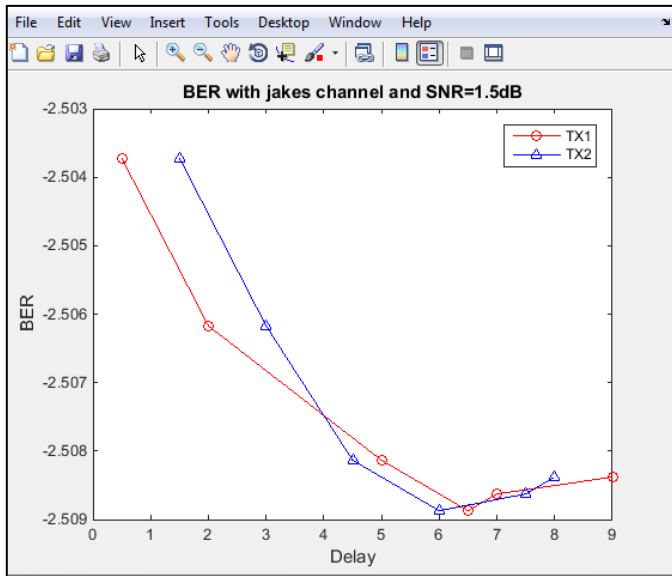

Figure 8. Result BER for various delay values

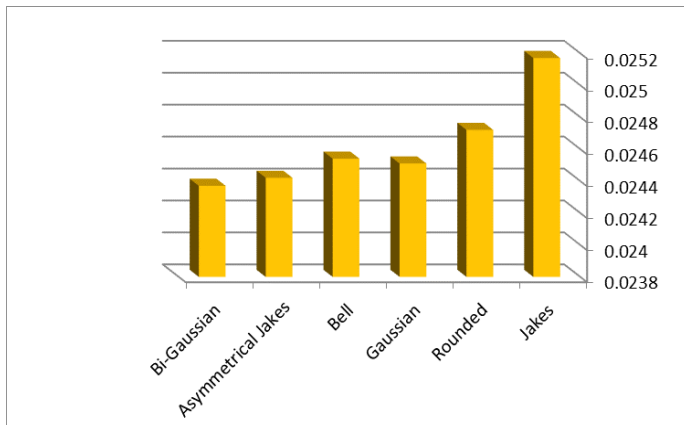

Figure 9. The graph of BER by changing channel model

Figure 9 shows the different values of BER of each channel model and it is clear that the Bi-Gaussian model has the smallest value of BER. Bi-Gaussian is selected to be the better model for our simulation model.

Table 1. Delay and channel model fixed BER

Delay : TX1= 1.5 , TX2= 3	
Channel Model : Jakes	
SNR	BER
-3	0.1827

0	0.1132
3	0.0534
6	0.01462
9	0.001472
12	0.0002478

In Table II, the values of delay are fixed to TX1= 1.5 μ s and TX2= 3 μ s and the channels model are set as Jakes, while varying the SNR value. The results show that the BER values are starting to decrease while the value of SNR is increase.

Conclusion

This work explains the MIMO systems and its implementation in Simulink. First, it accomplished the main objective to improve the bit error rate (BER) by applying a signal-processing technique at each side of the system. This technique was capable of increasing the channel capacity and reliability of wireless channel without increasing the system bandwidth and transmitter power. The MIMO system is already used in 3G and 4G mobile communication.

The past approaches to diversity schemes made use of antenna array's for improving demodulation performance at various complexity levels. As technology has slowly shifted to transmit diversity, the information has now spread to multiple antennas at the transmitter. The researchers of MIMO technology have focused on signal processing, channel modeling and coding aspects rather than the antenna design issues. On the other hand, MIMO systems can be implemented into both base station antennas and small devices such as mobile, laptop and Personal Digital Assistants (PDAs).

The system can further be improved by changing the channels and receivers design to reduce the value of BER to 0. This can make the system works without any error and thus, can be used in real-applications of wireless communication systems.

References

- [1] V. Tarokh, H. Jafarkhani, and a. R. Calderbank, "Space – Time Block Codes from Orthogonal Designs," *IEEE Trans. Inf. Theory*, vol. 45, no. 5, pp. 1456–1467, 1999.
- [2] D. Tse, D. Tse, P. Viswanath, and P. Viswanath, "Fundamentals of Wireless Communication I," *Notes*, p. 583, 2004.
- [3] A Paulraj, "Introduction to Space-Time," *System*, p. 277, 2003.
- [4] M. Kahn, "Layered space-time codes for wireless communications using multiple transmit antennas," *1999 IEEE Int. Conf. Commun. (Cat. No. 99CH36311)*, vol. 1, pp. 436–440, 1999.
- [5] O. Bjective and P. R. E. Ab, "QAM Transmitter Implementation," pp. 1–8.
- [6] A. Yener and S. Ulukus, "Wireless Physical-Layer Security: Lessons Learned from Information Theory," *Proc. IEEE*, vol. 103, no. 10, pp. 1814–1825, 2015.
- [7] M. Debole *et al.*, "A framework for estimating NBTI degradation of microarchitectural components," *Proc. Asia South Pacific Des. Autom. Conf. ASP-DAC*, pp. 455–460, 2009.
- [8] W. Chen, L. Hanzo, and Z. Cao, "Network Coded Modulation for two-way relaying," *2011 IEEE Wirel. Commun. Netw. Conf. WCNC 2011*, pp. 1765–1770, 2011.
- [9] A. Pandey, R. Ahmad, and D. P. Singh, "Comparison of Wireless MIMO System Under Alamouti's Scheme and Maximum Ratio Combining Technique," *Int. J. Image, Graph. Signal Process.*, vol. 5, no. February, pp. 31–37, 2013.
- [10] D. A. Gore and A. J. Paulraj, "MIMO antenna subset selection with space-time coding," *IEEE Trans. Signal Process.*, vol. 50, no. 10, pp. 2580–2588, 2002.
- [11] G. Garbo and S. Mangione, "An improved detection technique for cyclic-prefixed OFDM," *J. Networks*, vol. 5, no. 7, pp. 759–765, 2010.